

Teletype Corporation

**4420 & 4424 buffered
display terminals
for point-to-point systems**



features and selection guide



November 1, 1981

STANDARD FEATURES

4420

- **Transmission**

- **Communication modes:**

- **Sending:** Character-at-a-time, line-at-a-time, or block/page

- **Receiving:** To the display and/or optional printer

- **Local modes:** Keyboard to display; display to printer

- **Technique:** Asynchronous

- **Speed:** Up to 9600 bps (speeds above 2400 bps may require flow control)

- **Code:** 8-Level ASCII

- **Communication Interface:**

- EIA RS-232C compatible with 103, 108, 113, 201, 208, 209, and 212 type modems or equivalent; optional 20/60ma current loop via 403103 modification kit

- **Parity:**

- Odd, even, mark or space generation and detection

- **Automatic Answer:** With automatic speed select capability with 212 modem

- **Integrated Answerback:** Up to 40 characters, automatically or manually activated

- **Buffering:**

- 2K characters to the display; 2K characters to the printer; and 1K characters from the line

- **Alternate Options Group:** Allows changing from one group of on-line options to another by single key depression

- **Display:**

- **Screen size:** 5¼" x 11¼" viewing area (13" measured diagonally)

- **Format:** 24 lines x 80 characters

- **Memory:** 72 lines x 80 characters (5,760 characters)

- **Display method:** 7 x 9 dot matrix in 9 x 14 field refreshed 60 times/second

- **Character size:** .109W x .140H

- **Character set:** 128 displayable including ASCII control characters and space

- **Text Editing Aids**

- **Editing Keys:** Character insert and delete

- Line insert and delete

- Clear from cursor

- Bi-directional scrolling

- Segment Advance (24 lines)

- **Cursor Keys:** Cursor Home, Right, Left, Up, or Down

- Cursor Return and Cursor New Line

- Cursor Tab and Cursor Back Tab

- **Data Entry Aids**

- **Programmable PF keys:** Ten keys can be optioned for often used character strings such as sign on sequences, passwords, etc.

- **Cursor XY addressing and readout:** Cursor can be controlled remotely and positioned to any row and column with a single command

- **Form Enter:** Establishes protected fields. Protected characters are displayed at half-intensity

- **Form Transfer:** Sends all displayed data including protected

- **Visual Attributes:** Blink, underscore and inverse

- **Automatic "Skip" cursor tab:** Once an unprotected field is completed, the cursor automatically skips to the next unprotected field

- **Horizontal Tab Set & Clear:** Keyboard and on-line selectable

- **View Controls:** Displays graphic symbols for all ASCII control characters

- **Audible Alarm:** Adjustable; alerts operator to certain conditions, unacceptable entries

- **Cursor:** Full size rectangular cursor that inverses the character

- **Console:**

- Detached, typewriter-like arrangement with tactile feel, also available with 18 key numeric pad

- Generates all 128 ASCII code characters

- N-Key rollover feature.

- Repeat and line break keys

- Performs all edit and cursor functions by single key depression

- Visual indicators (lights) for terminal status

- **Additional Features:**

- Table of displayable options selectable from the keyboard—options and PF key sequences are stored in battery backed-up RAM.

- Selectable message ending, mode change, and disconnect characters

- Remote control of display and printer

- Screen tilt and brightness control

- **Optional Accessories**

- Printers

- Model 40 line printer, tractor feed (SSI interface)

- 300 lines per minute printing rate

- 80 or 132 column

- Horizontal and vertical tabulation

- Location up to 2000 ft from display

- Model 43 RO character printer, pin feed or friction feed (auxiliary EIA interface)

- 30 characters-per-second printing rate

- 132 column (Pin Feed), 80 column (Friction Feed)

- Location up to 50 ft from display

- Printer and paper alarms

- Pedestals optional

- **Electrical Requirements**

- **Input Voltage:** 115 VAC $\pm 10\%$ at 60 Hz $\pm .5\%$

- **Power Consumption:** 113 watts

- **Heat Generation:** BTU/hr 386

- **Environmental Requirements**

- **Temperature-Operating:** + 4.5°C to + 43°C (+ 40°F to + 110°F)

- **Relative Humidity-**Storage and operating (non-condensing) 5% to 95%

- **Physical Dimensions & Weight**

- **Display:** 15½"Wx14½"Hx15½"D;
Base diameter 15½"; Weight 46 lbs.

- **Keyboards**

- **Typewriter:** 15½"Wx3½"Hx6½"D; Wt. 8.25 lbs.

- Add 3¼" to width for numeric pad option

STANDARD FEATURES (Cont'd)

4424

• **Transmission**

Communications modes:

Sending: Character-at-a-time from the keyboard

Receiving: To the display and optional printer

Local modes: Keyboard to display; display to printer

Technique: Asynchronous over full-duplex facilities

Speed: Up to 9600 bps (speeds above 4800 bps may require flow control)

Code: 8-level ASCII

• **Communication Interface:**

EIA RS232-C compatible with 103, 108, 113, 201, 208, 209 and 212 type modems or equivalent; optional 20/60ma current loop via 403103 modification kit

• **Parity:** Odd, even, mark, space or none

• **Integrated Answerback:** up to 80 characters, automatically or manually activated

• **Buffering:** 2K characters to the display; 2K characters to the printer; and 1K characters from the line

• **Online Options Loading:** Options can be read, set or changed remotely

• **Display:**

Screen size: 5¼" x 11¼" viewing area (13" measured diagonally)

Format: 24 lines x 80 characters

Screen Memory: 48 lines x 80 characters (3840)

Display method: 8 x 14 dot matrix in 9 x 14 field

Character set: 128 ASCII characters including decenders plus 32 line drawing and special symbol graphics

• **Split Screen:** User configured screen with one scrolling area and up to two static regions—may be selected locally or on-line

• **Scrolling:** Bidirectional, up to 48 lines; with split screen option scrolling will consist of scrolling area (from 2 to 24 lines) and auxiliary data page (24 lines)

• **Automatic Destructive Scrolling:** Function permits continuous on line reception with oldest data lost when display memory (48 lines) is exceeded. Newest data/blank line appears at bottom of screen, or with the Split Screen option, at the bottom of the scrolling area

• **Local and Online Editing Aids**

Editing Functions:

Single or multiple character insert and delete

Single or multiple line delete

Clear full or partial lines, above/below cursor position

Cursor: Full size rectangular cursor that inverts the character

Cursor Functions:

Cursor Home, Right, Left, Up or Down

Cursor Return and Cursor New Line

Cursor Index and Cursor Tab

• **Cursor XY Addressing and Readout:** Cursor can be controlled remotely and positioned to any row or column with a single command

• **Programmable PF Keys:** Each of the 16 keys on the numeric pad can be optioned as PF keys to initiate programmed operations commonly associated with the user's applications. 80 characters are available for allocation among the PF keys and the Answerback.

• **Visual Attributes:** Two intensity levels plus bold/blink, inverse video and underscore

• **Horizontal Tab Set & Clear:** local and online settable

• **Operator Alert:** Console Alert key flashes when host wishes operator attention

• **Console:**

Detached, typewriter-like arrangement with 16 key numeric pad

Generates all 128 ASCII code characters

N-key rollover feature

Repeat and line-break keys

14 visual indicators (leds) report terminal status

• **Additional Features:**

Menu of displayable options selectable from the keyboard

Options, PF key sequences, and Answerback coding are stored in battery backed-up RAM

Remote control of display and printer via escape sequences

Screen tilt and brightness control

Self-diagnostics

• **Optional Accessories**

Auxiliary EIA port accommodates model 40 line printers (up to 300 lpm) or model 43 character printers (30 cps)

SSI interface accommodates model 40 line printers

Pedestals optional

Electrical Requirements

• **Input Voltage:** 115 VAC ± 10% at 60 Hz ± .5%

• **Power Consumption:** 113 watts

• **Heat Generation:** BTU/hr 386

Environmental Requirements

• **Temperature-Operating:** + 4.5°C to + 43°C (+ 40°F to + 110°F)

• **Relative Humidity-**Storage and operating (non-condensing) 5% to 95%

Physical Dimensions & Weight

• **Display:** 15½"Wx14½"Hx15½"D;
Base diameter 15½"; Weight 46 lbs.

• **Keyboard:** 19½"Wx3½"Hx6½"D; Wt. 10 lbs.

SELECTION GUIDE

KEYBOARD DISPLAY (KD) AND ACCESSORIES

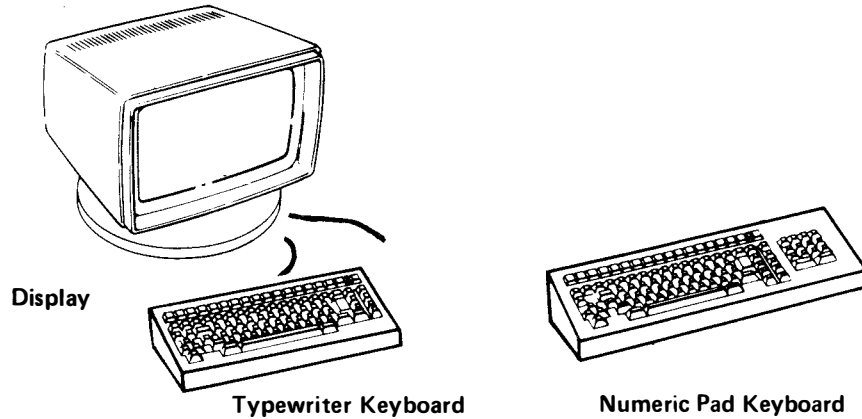

Keyboard Display (KD)

Type of Terminal		Type of Keyboard		Catalog Number*
Alpha-Numeric	Alpha-Numeric/Graphics	Typewriter	Numeric Pad	
●		●		4420-10FA
●			●	4420-10FB
	●		●	4424-10AB

*EIA cable to connect KD to modem must be ordered separately from table at right.

KD Accessories

Catalog Number
403103 20/60 ma current loop mod kit
408065 EIA cable - 7'*
408066 EIA cable - 12'*
408067 EIA cable - 25'*
408068 EIA cable - 50'*

*Used to connect KD to modem and to connect optional Model 43 Printer to KD

OPTIONAL PRINTERS AND ACCESSORIES

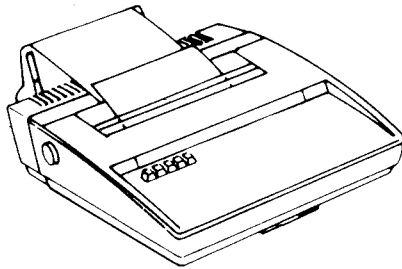

Model 43
Friction Feed
Printer

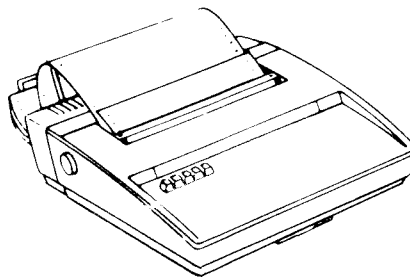

Model 43
Pinfeed Printer

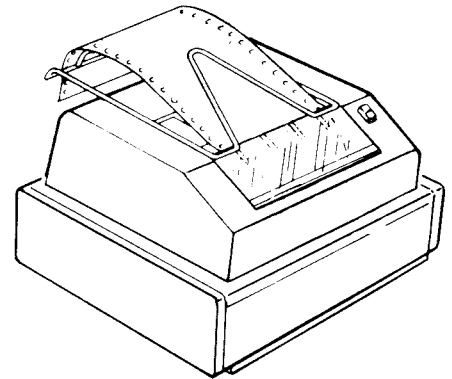

Model 40
Tractor Feed
Printer

Printers

Type & Speed		Paper Feed			Line Length		Catalog Number
Model 43** 30 cps	Model 40* 300 lpm	Friction	Tractor	Pin	80 Columns	132 Columns	
●		●			●		4310AAH
●				●		●	4310AAG
	●		●		●		4011-4JOO
	●		●			●	4011-4MOO

* Cable 348138 must be ordered separately to connect Model 40 Printer to KD

** Order an EIA cable from KD Accessories selection guide to connect Model 43 Printer to KD

PRINTER ACCESSORIES

4420 & 4424
November 1, 1981

Model 40 Pedestals

Pedestal Width	Top Width				Slot Width		Catalog Number
	20"	24"	27"	31"	11"†	17"‡	
20"*	●				●		4000-400F
24"		●			●		4000-400E
			●			●	4000-400L
				●	●		4000-400B
27"*			●		●	4000-400J	

† accommodates 80 column tractor feed printer

‡ accommodates 80 or 132 column tractor feed printer

* allows paper supply box to be slid under pedestal top to rear of pedestal (no door)

Model 40 Miscellaneous Accessories

Catalog Number
402444 Ribbon
Form Length Belts
402571
402572
402573
402574
402575
402576
402577
402578
402579
402580
402586 Set of belts (all the above)
402587 Set of belts
Consists of 402571, 402572, 402573, 402575 & 402578
405544 Form accumulator rack
408990 80 column reinker mod. kit
407790 132 column reinker mod. kit
402850 Ribbonless printing mod. kit
402920 Paper jam mod. kit

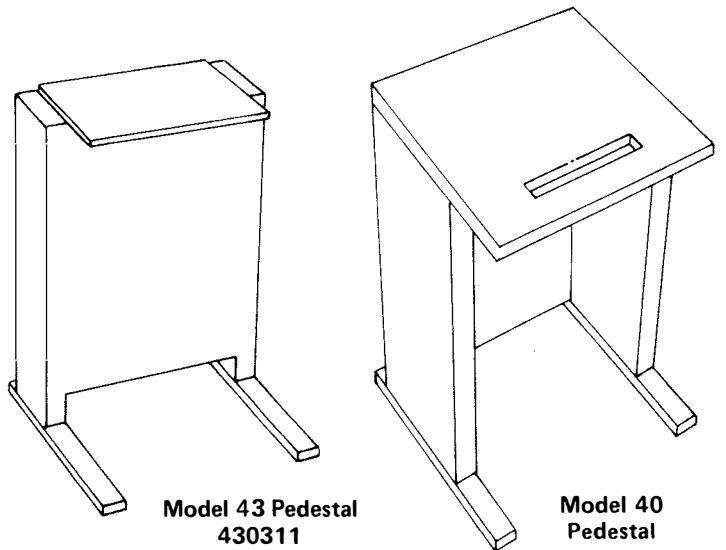

TELETYPE CORPORATION

GENERAL OFFICES: 5555 Touhy Avenue, Skokie, Illinois 60077 Telephone: (312) 982-2000—TWX: 910-223-3611 and TELEX: 25-4051 (both have 24 hour automatic answering service)

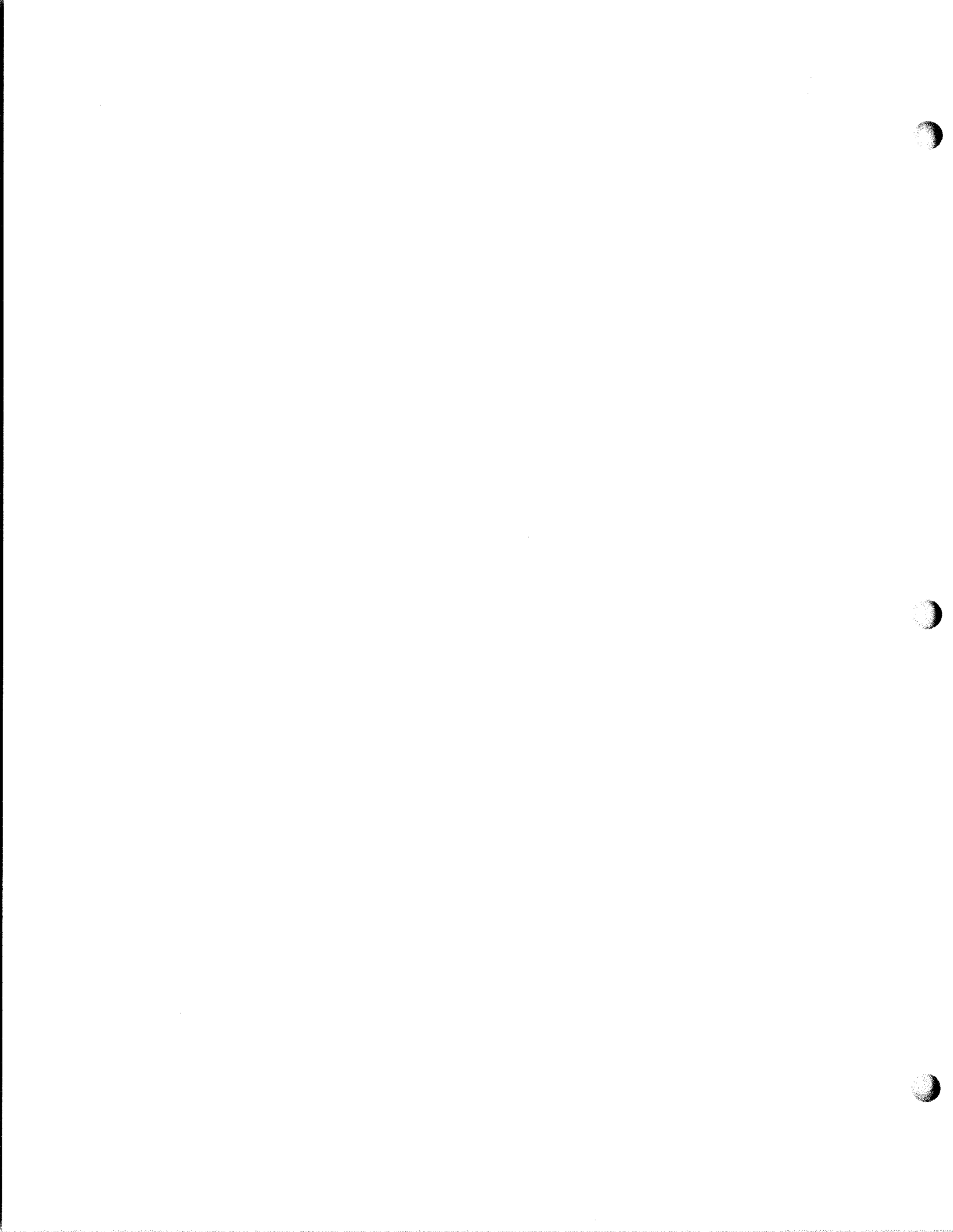

Teletype Corporation

**4430 buffered
multi-point
display terminal**



features and selection guide



NOVEMBER 1, 1981

FEATURES AND SPECIFICATIONS

• Transmission

Communication modes:

Send: Block or page from buffers—display send buffer; auxiliary send buffer (optional)

Receive: Block or page to buffers (only by option)—display receive buffer; printer receive buffer; auxiliary receive buffer

Local Modes: Messages may be sent locally from the display to the printer (via the printer port), the display to the auxiliary device, from the auxiliary device to the display, and the auxiliary device to the printer.

Technique: Asynchronous/Isochronous

Speed: Up to 4800 bps

Code: 8-Level ASCII

• Communication Interfaces:

EIA RS-232C Compatible with 108, 201, 202 and 208 type modems or equivalent; Current 20/60 ma; requires EIA to current adapter

403103 (125 VDC Max.) or 420301 (130 ± VDC Max.)

Display SSI (Standard Serial Interface) port supports an optional Teletype printer

Display auxiliary port supports an optional EIA send/receive device: another 4430 KD; model 43BSR teleprinter; or model 43 paper tape module; or a compatible commercial device

• Communication Function:

Multi-Point Station selectivity (Poll/Select) with:

Establishment Status Replies

Message Transfer Transmission checking with

Automatic Retransmission

Controlled Retransmission

Longitudinal Redundancy Checking

Termination with Transmission checking

Roll call with status replies

• Protocol Compatibility:

ANSI 3.28 Subcategories 1.1, 2.4, thru 2.8, A1, A3 and A4
85A Optional Procedures

8A1

Poll/Select with LRC

Contention Operation

• Parity:

Odd, even, 1 or 0 generation and detection

• Buffer Details:

Approximately 14K buffer storage is available less display refresh buffer allocation—up to 5760 characters (3 segments). Balance is committed to a buffer pool shared by the display send and receive, auxiliary send and receive and printer receive buffers. Status of the five buffers appears on the 25th line of the display.

• Display:

Screen size: 5¼" x 11¼" viewing area (13" measured diagonally)

Screen format: 24 lines x 80 characters

Memory: Selectable option—up to 72 lines

Display method: 7 x 9 dot matrix in 9 x 14 field refreshed 60 times/second

Character set: 128 displayable including ASCII control characters and space

• Text Editing Aids

Editing Keys: Character insert and delete; Line insert and delete; Clear from cursor; Bi-directional scrolling; Segment Advance (24 lines).

Cursor Keys: Cursor Home, Right, Left, Up or Down
Cursor Return and Cursor New Line

• Data Entry Aids

One User-Programmable function key: Can be optioned for often used character strings (15 characters) such as header sequence, special text, etc.

Cursor XY addressing and readout: Cursor can be controlled remotely and positioned to any row and column with a single command

Automatic "Skip" cursor tab: Once an unprotected field is completed, the cursor automatically skips to the next unprotected field

Form Enter: Establishes protected fields. Protected characters are displayed at half-intensity

Form Transfer: Sends all displayed data including delimiters

Highlight: Character positions blink from half to full intensity

Horizontal Tab Set & Clear: Keyboard and on-line selectable

View Controls: Displays graphic symbols for all ASCII control characters

Underscore: Characters in display memory can be underscored from the keyboard or on-line

• Console:

Detached, typewriter-like arrangement; also available with 18 key numeric pad; generates all 128 ASCII code characters

• Additional Features:

Table of displayable options cursor selectable-options and PF key sequences are stored in battery backed-up RAM

Buffer Status Line: 25th line displays individual buffer availability in terms of data blocks (256 bytes per block)

Optional screen fill character on Message "Clear"

Priority Send and Response

Contention operation

• Optional Accessories

Auxiliary EIA Port Options: 4430 KD; model 40 Printer; model 40 ROP; model 43 BSR (MPPL); model 43 RO; model 43 Tape Send-Receive Module; or compatible storage device

Printer Port Options: Model 40 line printer

• Additional 16K RAM input/output buffering

Electrical Requirements

• **Input Voltage:** 115 VAC ± 10% at 60 Hz ± .5%

• **Power Consumption:** 122 watts max.

• **Heat Generation:** BTU/hr 417

Environmental Requirements

• **Temperature-Operating:** +4.5°C to +43°C (+40°F to +110°F)

• **Relative Humidity—**Storage and operating (non-condensing) 5% to 95%

Physical Dimensions & Weight

• **Display:** 15½"W x 14½"H x 15½"D;
Base diameter 15½"; Weight 45 lbs.

• **Keyboard:** 15½"W x 3½"H x 6½"D; Wt. 7.50 lbs.
Add 3¾" to width for numeric pad option

ORDERING GUIDE

REQUIRED

4431 Keyboard Display (Page 3)
and
EIA Cable to connect 4431 to Data Set (Page 7)

4340 Buffer Send Receive Teleprinter (Page 5)
or

4310 Receive Only Printer (Page 5)
or

4431 KD (Keyboard Display) (Page 5)
or

4350 TSR (Tape Send Receive) (Page 6)
or

40/3 Keyboard Display (Page 6)
and

Appropriate Auxiliary Device Cable to connect Auxiliary Device to 4431 Auxiliary EIA Port (Page 7)

OPTIONAL

4011 SSI Printer (Page 3)
and
SSI Cable to connect SSI Printer to 4431s SSI Port (Page 7)

410168 Ram Card (Page 8)

One of the following Auxiliary Devices:

4011 EIA Printer (Page 4)

or

4010 Receive Only Printer (Page 4)

or

SELECTION GUIDE

PRIMARY TERMINAL

4431 KD (Keyboard-Display)

Terminal	Catalog Number
Buffered Multi-Point	4431-1FFA

EIA cables to connect 4431 KD to Data Set must be ordered separately from table on page 7.

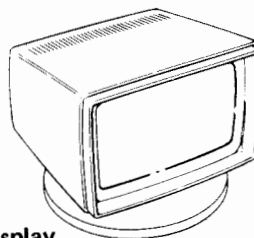

Display



Keyboard

4011 SSI Printers

Type of Printer		Line Length Max.	ASCII Character Set		Catalog Number
Friction	Tractor	80 Column	Monocase	Full ASCII	
•		•	•		4011-3B00
•		•		•	4011-3E00
	•	•	•		4011-4G00
	•	•		•	4011-4J00

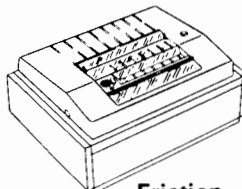

Friction Feed

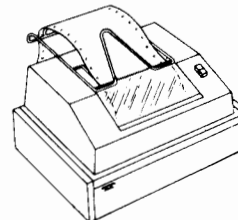

Tractor Feed

Cable to connect SSI Printer to 4431 KD must be ordered separately from table on page 7.

AUXILIARY DEVICES

RECEIVE ONLY

4011 EIA Printers

Type of Printer			Line Length Max.		ASCII Character Set		Catalog Number
Friction	Tractor	Forms Access	80 Column	132 Column	Monocase	Full ASCII	
•			•		•		4011-1BOO
•			•			•	4011-1EOO
	•	•	•		•		4011-1AON
	•	•	•			•	4011-1DON
	•		•		•		4011-1GOO
	•		•			•	4011-1JOO
	•			•	•		4011-1LOO
	•			•		•	4011-1MOO

Cables to connect Auxiliary Device to 4431 KD must be ordered separately from table on page 7.

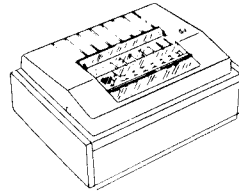

Friction Feed

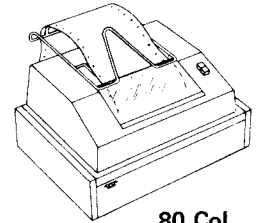

80 Col. Tractor Feed

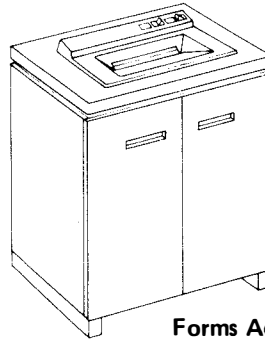

Forms Access

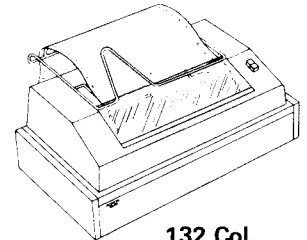

132 Col. Tractor Feed

4010 ROP (Receive Only Printer)

Type of Printer			Line Length Max.		ASCII Character Set		Catalog Number
Friction	Tractor	Forms Access	80 Column	132 Column	Monocase	Full ASCII	
		•	•		•		4010-1AON
		•	•			•	4010-1DON
•			•		•		4010-1COO
•			•			•	4010-1FOO
	•		•		•		4010-1HOO
	•		•			•	4010-1KOO
	•			•	•		4010-1LOO
	•			•		•	4010-1MOO

Cables to connect Auxiliary Device to 4431 KD must be ordered separately from table on page 7.

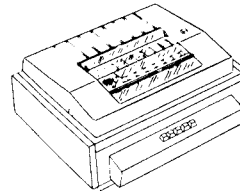

Friction Feed

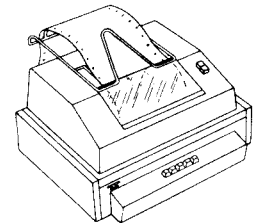

80 Col. Tractor Feed

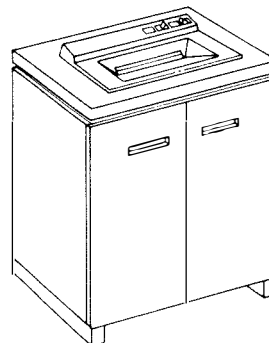

Forms Access

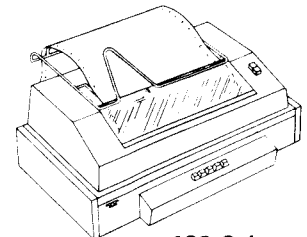

132 Col. Tractor Feed

4340 BSR (Buffer Send Receive)

Type of Printer			Catalog Number
Pin Feed	Friction Feed	Tractor Feed	
•			4340BBB
	•		4340BBD
		•	4340BBJ

Cable to connect Auxiliary Device to 4431 KD must be ordered separately from table on page 7.

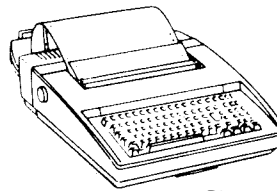

Pin Feed

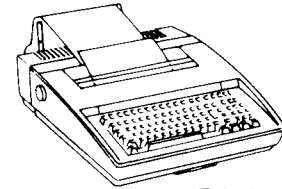

Friction Feed

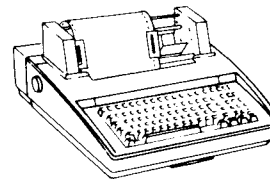

Tractor Feed

4310 RO (Receive Only)

Type of Printer		Catalog Number
Pin Feed	Friction Feed	
•		4310AAG
	•	4310AAH

Cable to connect Auxiliary Device to 4431 KD must be ordered separately from table on page 7.

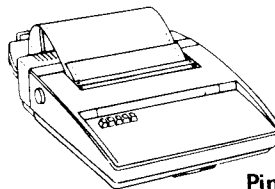

Pin Feed

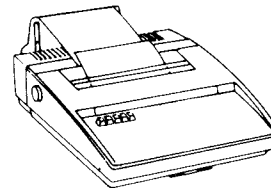

Friction Feed

SEND-RECEIVE

4431 KD (Keyboard-Display)

Optioned for Auxiliary Terminal Operation

Catalog Number: 4431-1FFA

Cable to connect Auxiliary Terminal to 4431 KD must be ordered separately from table on page 7.

4350 TSR (Tape Send Receive)

Interface	Punch & Reader	Catalog Number
Limited EIA	Auto/Man'l	4350AAA
	Auto	4350AAC
	Man'l	4350AAB

Cable to connect Auxiliary Device to 4431 KD must be ordered separately from table on page 7.

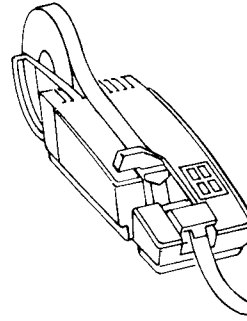

COM-STOR II* Storage Unit

Model 8120

NOT OFFERED BY OR AVAILABLE FROM TELETYPE CORPORATION

Cable to connect Auxiliary Device to 4431 KD is available and must be ordered separately from table on page 7.

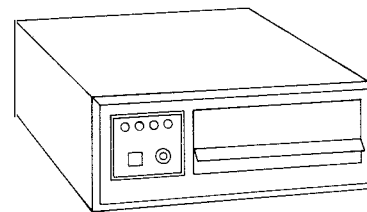

*Registered Trademark of Sykes Datatronics

Model 40/3 Keyboard Display **

Display Memory Size			Tab Control, Highlight & Protected Data Features	Catalog Number
24-line	48-line	72-line		
•	•	•	•	4025-20DA
	•		•	4025-20EA
		•	•	4025-20FA

Cable to connect Auxiliary Device to 4431 KD must be ordered separately from table on page 7.

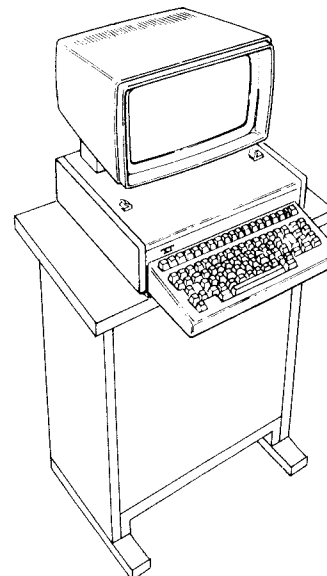

**Included not for ordering purposes, but for customers who wish to reuse this product with the 4430.

CABLES

Data Set Cables

Catalog Number	Length (Ft.)
430569	3
408065	7
408066	12
408067	25
408068	50

Primary Terminal

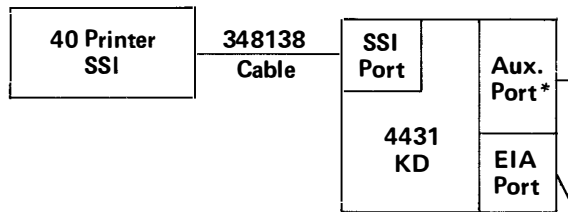

Auxiliary Device Cables

Catalog Number	Length (Ft.)	Catalog Number	Length (Ft.)
348138	10	413603	50
405306	6	413604	7
405307	12	413605	7
405308	25	413606	7
405309	50	413610	7
413600	7	413611	7
413601	12	413612	7
413602	25		

Data Set Cable
430569,
408065-068

Data Set

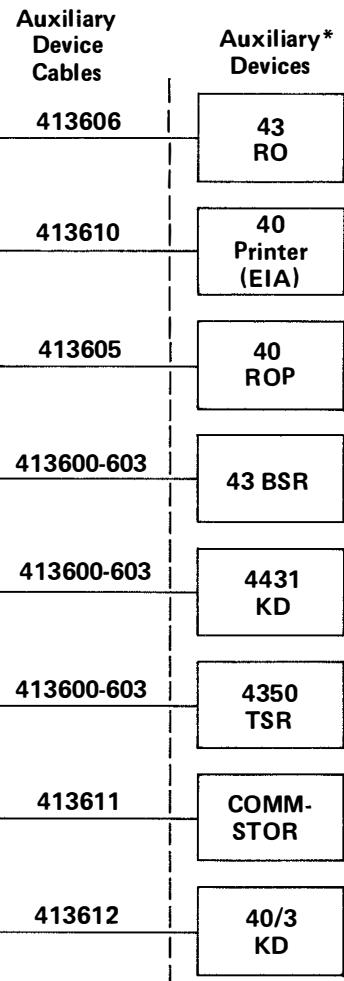

SEE NOTE 1

The length of auxiliary cable 413605, 413606, 413610, 413611 or 413612 can be increased by connection to cable 413600, 413601, 413602 or 413603. When this is done, the 413600-603 cable should connect to the prime terminal and the auxiliary cable should connect to the auxiliary terminal.

The 348138 SSI device cable may be extended by adding the appropriate extension cable 405306 through 405309. The extension cable must be connected between the printer cabinet SSI connector and the 348138 cable connector.

*Supports one auxiliary device

NOTE 1
Must be Optioned for Auxiliary Device Operation

COMPONENTS

Catalog Number 4431-1FFA consists of the following components:

DESCRIPTION	CATALOG NUMBER
Opcon Base	40 BSE 201
Opcon	40K 106 CAD
Monitor	40MN 101 AA
Controller-Base	45C 320 AAD 999
Feature Group	45FG 411 AA 01
Interconnect Cable	348124
Keypop (Modification Kit)	411382
All the above shipped as components	4431-1FFA-1

ACCESSORIES

Ram Card – 410168

An optional 410168 Ram Card may be added to increase the amount of terminal memory from 16K to 32K.

This is highly advisable for terminals in which a 3 Segment Display is desired.

Model 43 Pedestal – 430311

Adds 25 inches to terminal height and 22 lbs. to weight.

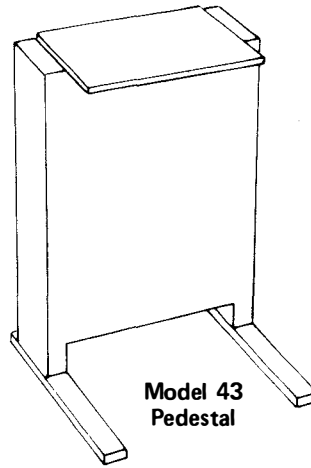

Model 43 Pedestal

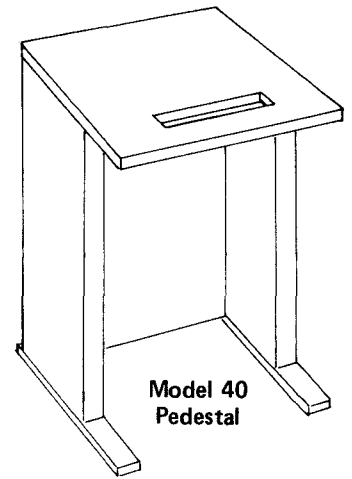

Model 40 Pedestal

Model 40 Pedestals (empty)

Pedestal Width	Top Width						Slot Width			Catalog Number
	20"	24"	27"	29"	31"	34"	None	11"†	17"‡	
20"*	•							•		4000-400F
24"		•					•			4000-400D
		•						•		4000-400E
			•						•	4000-400L
				•			•			4000-400A
					•			•		4000-400B
27"*						•	•			4000-400C
			•						•	4000-400J

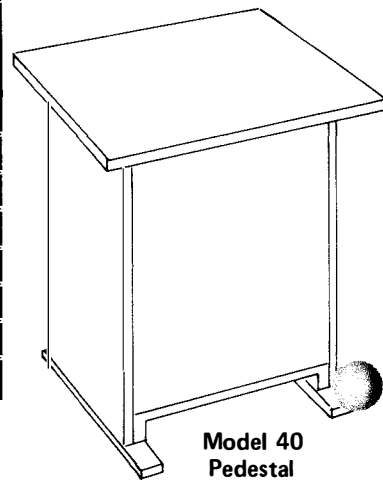

Model 40 Pedestal

†accommodates 80 column tractor feed printer

‡accommodates 80 or 132 column tractor feed printer

*allows paper supply box to be slid under pedestal top to rear of pedestal (no door)

Model 43 Miscellaneous Accessories

Catalog Number
13 to 10 char/in conversion
430284 Scale
430285 Belt
430319 Pulley
430035 Spare Print Ribbon
430310 Copyholder (not available for tractor feed printers)

Model 40 Printer Miscellaneous Accessories

Catalog Number
402444 Ribbon
Form Length Belts
402571
402572
402573
402574
402575
402576
402577
402578
402579
402580
402586 Set of belts (all the above)
402587 Set of belts Consists of 402571, 402572, 402573, 402575 & 402578
405544 Form accumulator rack
408990 80 column reinker mod. kit
407790 132 column reinker mod. kit
402850 Ribbonless printing mod. kit
402920 Paper jam mod. kit

TELETYPE CORPORATION

GENERAL OFFICES: 5555 Touhy Avenue, Skokie, Illinois 60077 Telephone: (312) 982-2000—TWX: 910-223-3611 and TELEX: 25-4051 (both have 24 hour automatic answering service)